

Article number: 01010401
 Description: Retaining ring A 23 DIN 471
 Stainless 411
 Note: Fitted with ZGA pilers

Measures

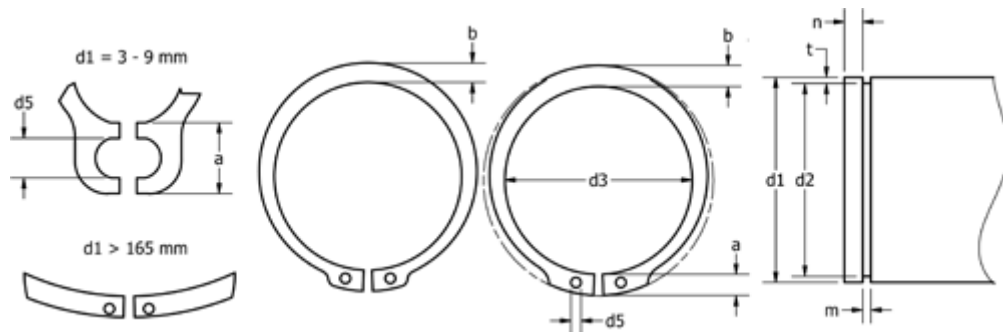

a max	= 4.3	FN kN	= 5.9	s	= 1.20
AN mm ²	= 35.4	FRg kN	= 3.80	t	= 0.50
b	= 2.9	FR kN	= 16.60	tol	= -0.15
d1	= 23	g	= 1.5	tol	= -0.06
d2	= 22.0	K kN-mm	= 34.70	tol	= +0,13-0,42
d3	= 21.5	m min	= 1.30	Tong	= ZGA-2
d5 min	= 2.0	n abl x 1000	= 25.0	Weight kg/1000	= 1.630
Description	= A23	Nominal drive	= 1.5		